

| REV. NO |      | REV. HISTORY    | LTR | ECO NO | DATE | APPR'L |
|---------|------|-----------------|-----|--------|------|--------|
| DWG     | PART |                 |     |        |      |        |
| 00      | 00   | INITIAL RELEASE | -   | -      | -    | -      |

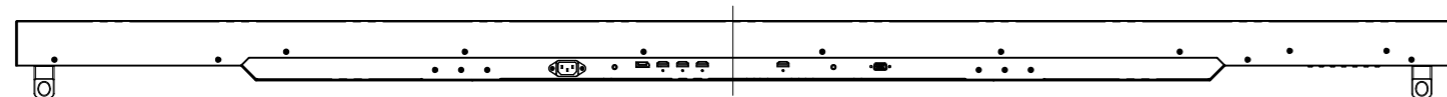
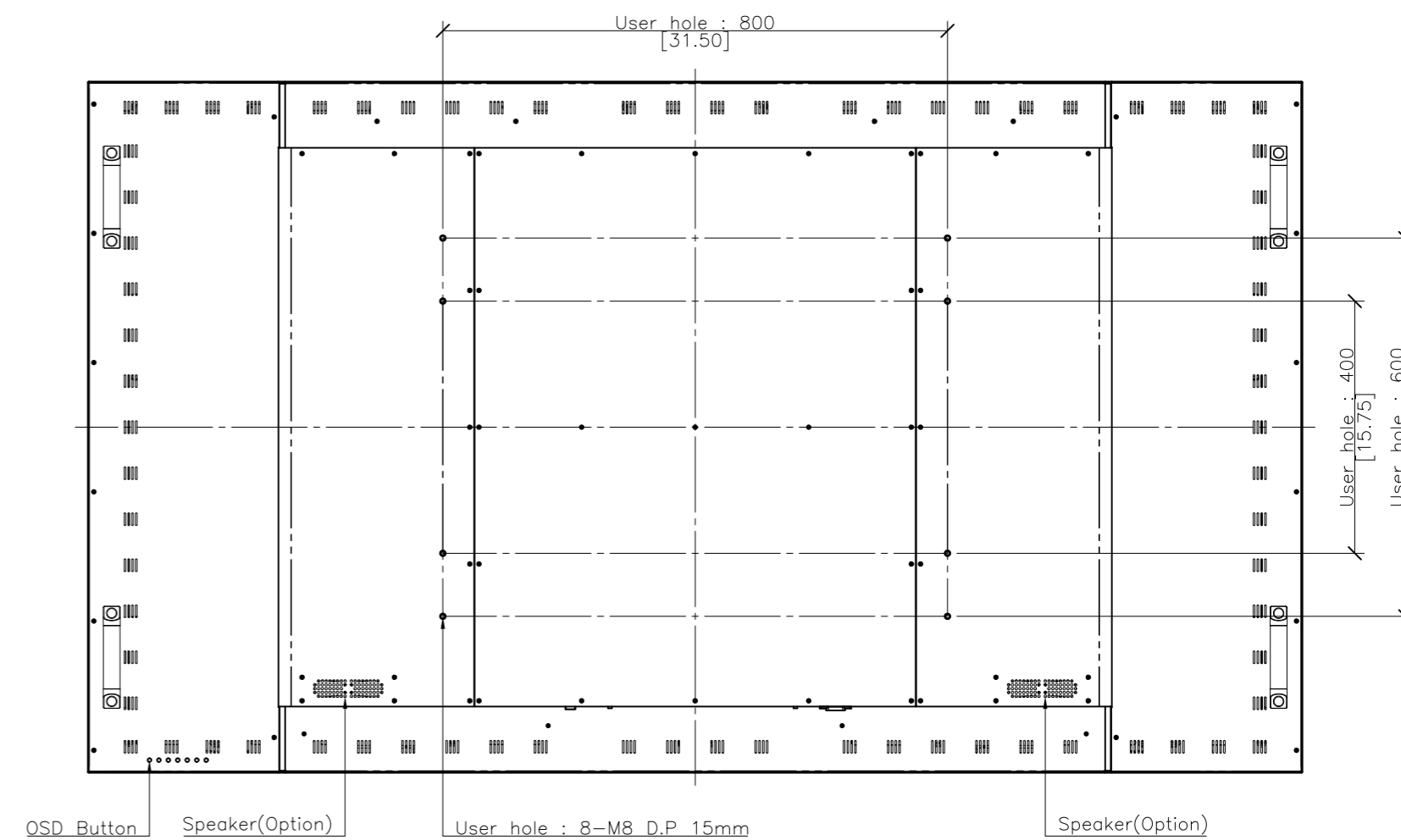
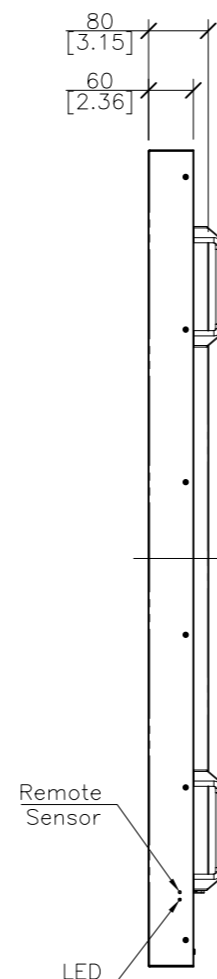
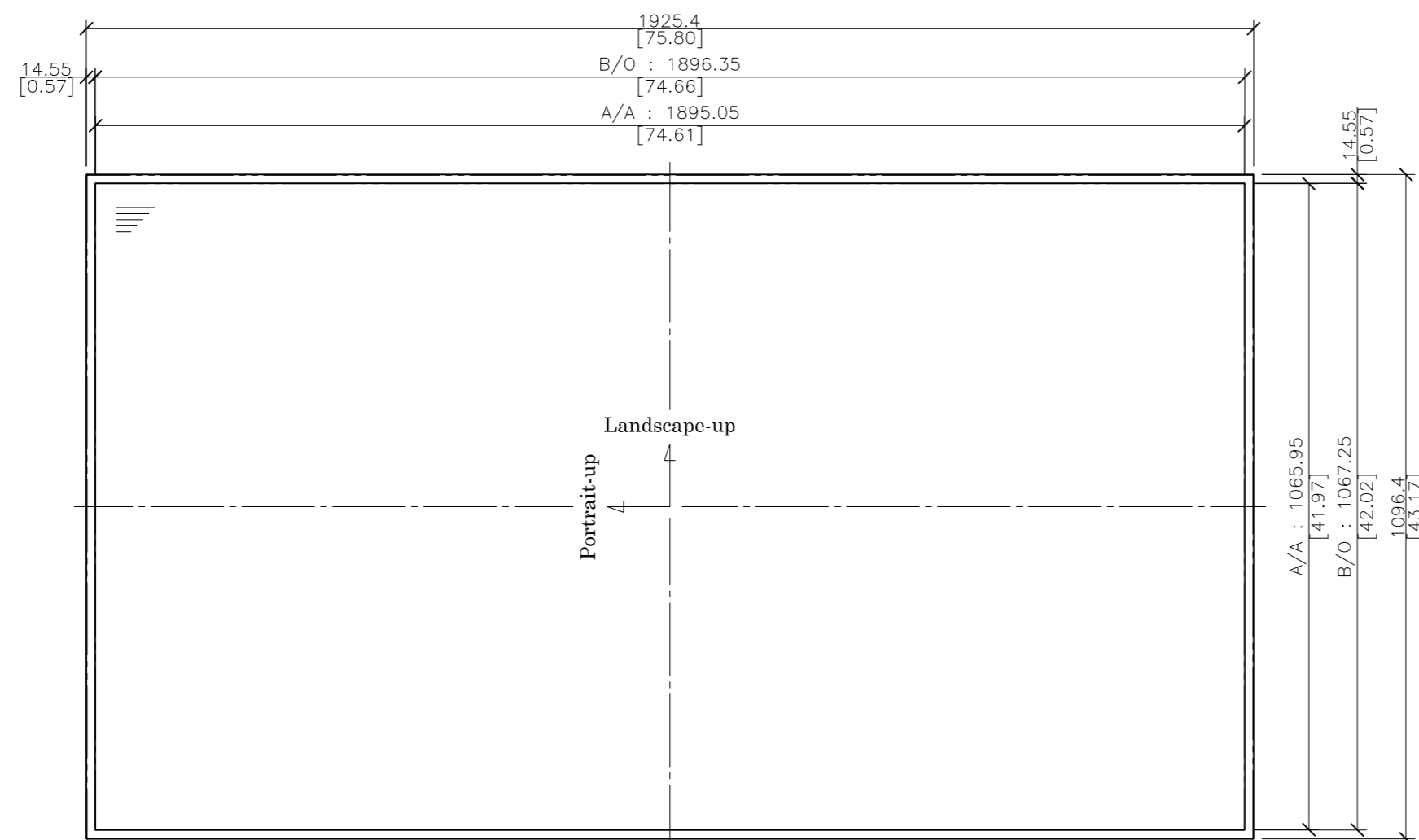
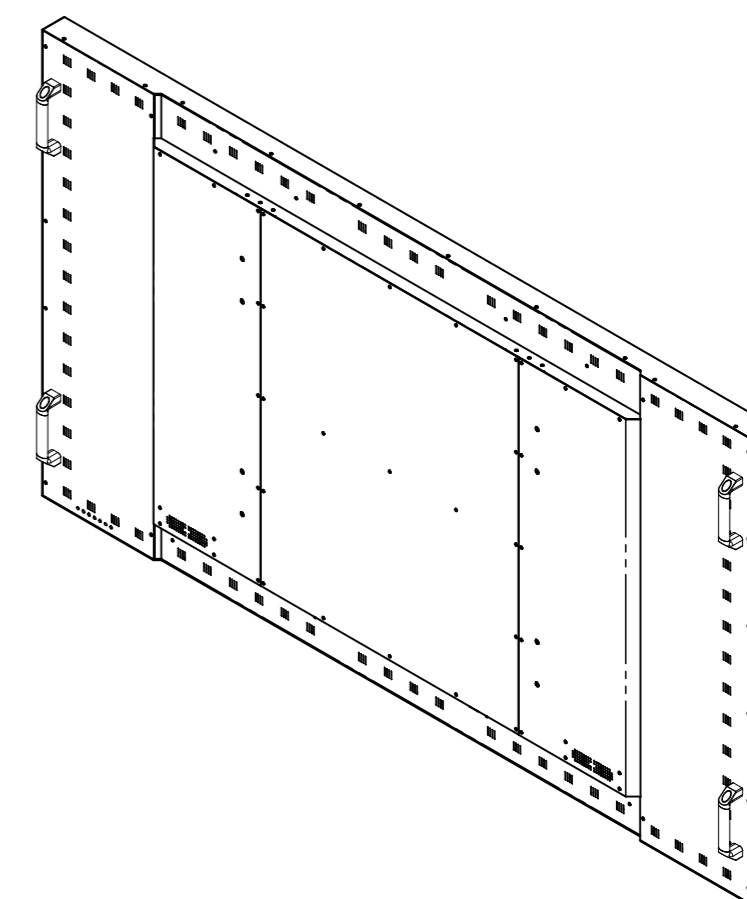
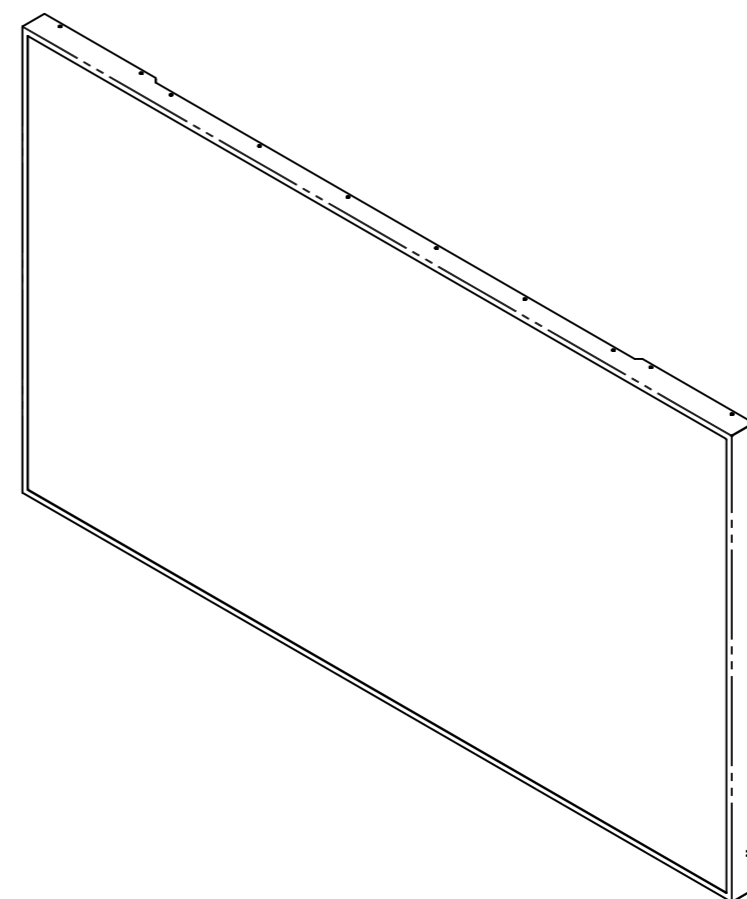
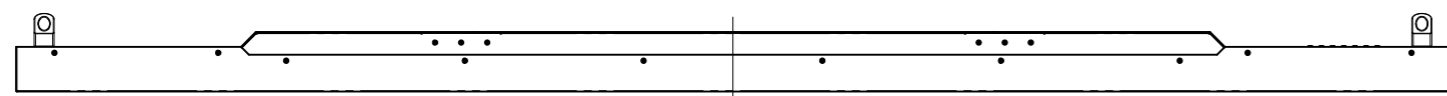

- NOTES**
- LCD Panel : 86" LED Back Light Panel
  - Tempered Glass : 5.0t
  - Material : E.G.I
  - Color : Black

| DRAWN                      | PLANNED   | CHECKED   | APPROVED  | UNLESS OTHERWISE SPECIFIED<br>ALL DIMENSION ARE IN MILLIMETERS  | ANGLE<br>3rd.    | TITLE :                      | UNIT :<br>mm   |
|----------------------------|-----------|-----------|-----------|---|------------------|------------------------------|----------------|
| S.W.SEO                    | S.H.JANG  | S.H.JANG  | Y.T.KIM   | TOLERANCES ARE:<br>LINEAR : X ± 0.20 X ± 0.1 XX ± 0.01<br>ANGLE : ± 0.1°<br>RADI UNLESS NOTED : R 0.3 | SCALE :<br>1/10  | D86XMXG<br>EXTERIOR VIEW     | TYPE :<br>ASSY |
| '17.03.06                  | '17.03.06 | '17.03.06 | '17.03.06 |   |                  | DWG(PART) NO.<br>D86XMXG_001 | SIZE :<br>A2   |
| <b>HYUNDAI IT CO.,LTD.</b> |           |           |           | MODEL NAME (CODE):<br>D86XMXG   | CUSTOMER:<br>HDT | DWG REV :<br>00              |                |
|                            |           |           |           | FILE NAME :<br>LAYOUT_D86XM_170306.DWG  |                  | SHT NO :<br>1/1              |                |

This drawing is the property of HYUNDAI IT CO.,LTD. and should not be disclosed to any third party without prior permission of HYUNDAI IT CO.,LTD..